



**LOGY, S.L.**  
EQUIPAMIENTOS - NATACIÓN



**NADANDO  
JUNTOS**



**2023**



## ÍNDICE

## INDEX

## INDEX

Pag.	FLOTADORES Y JUEGOS	FLOTADORS I JOCS	FLOATERS & GAMES
6-7	Flotadores	Flotadors	Floaters
8	Fritas	Frites	Fun Noodles
9-11	Figuras y tapices	Figures i catifes	Figures & Playrafts
12	Deportes	Esports	Sports
13-14	Juegos	Jocs	Games

Pag.	NATACIÓN	NATACIÓ	SWIMMING
16	Gorros	Casquets	Caps
17	Gafas	Ulleres	Goggles
18-19	Aletas	Aletes	Fins
20	Complementos	Complements	Complements

Pag.	ENTRENAMIENTO	ENTRENAMENT	TRAINING
22	Pull-buoy	Pull-buoy	Pull-buoy
23	Manoplas y guantes	Manoples i guants	Handpaddles & gloves
24-28	Aquagym y complementos	Aquagym i complements	Aquagym & complements

Pag.	EQUIPAMIENTOS	EQUIPAMENTS	EQUIPMENT
30-33	Líneas de flotación	Línies de flotació	Swimming lanes
34	Anclajes	Ancoratges	Anchorage
35	Podiums	Podiums	Podiums
36-37	Competición	Competició	Competition
38-39	Waterpolo	Waterpolo	Waterpolo
40	Rejillas	Reixetes	Grids
41	Escaleras y duchas	Escales i dutxes	Ladders & showers
42-43	Elevadores	Elevadors	Lifts
44-45	Salvamento	Salvament	S.O.S.
46-47	Relojes	Relotges	Clocks
48-55	Equipamentos de instalación	Equipaments d'instalació	Facility equipment
56-57	Cubiertas y enrolladores	Cobertes i enrotlladors	Covers & winches
58-59	Equipamiento piscina	Equipament piscina	Swimming pool facilities



# FLOTADORES Y JUEGOS

Pag.	FLOTADORES Y JUEGOS	FLOTADORS I JOCS	FLOATERS & GAMES
6-7	Flotadores	Flotadors	Floateres
8	Fritas	Frites	Fun Noodles
9-11	Figuras y tapices	Figures i catifes	Figures & Playrafts
12	Deportes	Esports	Sports
13-14	Juegos	Jocs	Games
15-18	Psicomotriz y protección	Psicomotriu i protecció	Psychomotor & protection



1000



Burbujita



1001



Funda Burbujita color  
Funda Burbujita color  
Burbujita colour cover



1002

Funda Burbujita personalizada  
Funda Burbujita personalitzada  
Customized Burbujita cover



1003



Burbujita Fauna



1004



Burbujita Paint



1300/1301



Cinturón aprendizaje infantil  
Cinturó aprenentatge infantil  
Children's learning belt  
1300: Infantil/Child  
1301: Adultos/Adults



1100/1101



1100:  
9 elementos/elements  
Cinturón Suro infantil  
Cinturó Suro infantil  
Children's Suro belt

1101:  
14 elementos/elements  
Cinturón Suro adulto  
Cinturó Suro adult  
Adult's Suro belt



130/131

Recambio cinturón  
Recanvis cinturó  
Learning belt spare parts  
130: Infantil/Child  
131: Adultos/Adults



1200/1201



1200:  
5 elementos/elements  
Cinturón Aquafoam infantil  
Cinturó Aquafoam infantil  
Children's Aquafoam belt

1201:  
6 elementos/elements  
Cinturón Aquafoam adulto  
Cinturó Aquafoam adult  
Adult's Aquafoam belt

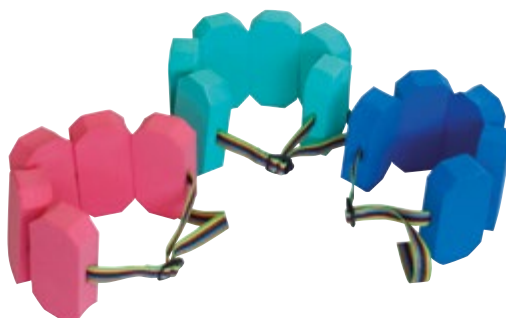

1400



Collar flotación  
Collaret flotació  
Flotating collar



1500



Cinturón Aquafoam tortuga  
Cinturó Aquafoam tortuga  
Aquafoam turtle belt



1501



Cinturón Aquafoam cangrejo  
Cinturó Aquafoam cranc  
Aquafoam crab belt



1600



Brazaletes Rol-lo  
Braçalet Rol-lo  
Rol-lo bracelet



1700



Brazaletes Aquafoam bebé/  
muñequera adulto  
Braçalet Aquafoam bebé/  
canellera adult  
Baby Aquafoam bracelet/ adult  
wristband



1701



Brazaletes Aquafoam junior  
Braçalet Aquafoam junior  
Aquafoam junior bracelet



1702



Beco Brazaletes/Braçalet/  
Bracelet  
Brazaletes duraderos que no hace falta  
hinchar. Constan de 3 discos en cada  
brazo que se pueden ir quitando de  
forma gradual y según flotabilidad que  
se vaya consiguiendo



 Flotabilidad/Flotabilitat/Buoyancy

 No Flota/No Buoyancy

 PVC

 Poliestireno

 Goma/Rubber

 Espuma/Escuma/Foam

 AL Aluminio/Alumini/Aluminium

 INOX Inoxidable/Stainless

 Recicable/Recycable

 Colores/Colors/Colours

 Juegos/Jocs/Games

 Relajante/Relaxant/Relaxing

 Ejercicios/Exercicis/Exercises

 Velcro

 Antideslizante/Antideslizant/Non-slip

 Espuma alta densidad/Escuma alta densitat/High density foam

 25 Espuma/Escuma/Foam 25 kgs.

 Tacto piel/Tàcte piel/Leather feel

 PVC Poliéster

 Resistente al agua/ resistant a l'aigua/  
Water proof

 Indeflexible/Non-deformable/  
Indeflexible

160

Rol-lo  
Recambios gomas brazaletes  
Recanvis gomes braçalet  
Rubber bracelet spare parts

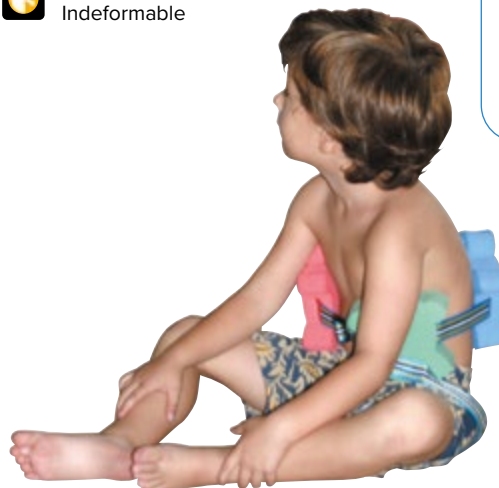

2000



8x8x100 cm.  
Fritas cuadradas  
Frites quadrades  
Square fun noodles

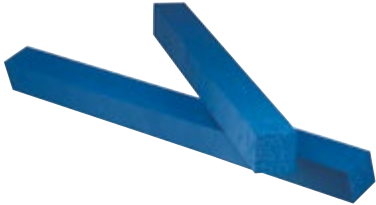

2001/2015



Aquafoam Fritas/Frites/  
Fun noodles  
2001: Ø 6,5x100 cm.  
2015: Ø 6,5x150 cm.

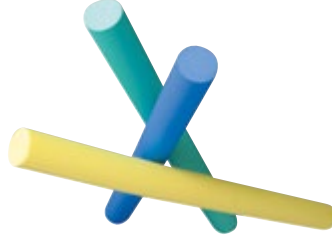

2002



Ø 6,5x150 cm.  
Fritas redondas sin agujero  
Frites rodones sense forat  
Round fun noodles no hole



2003



Ø 6,5x150 cm.  
Fritas redondas con agujero  
Frites quadrades amb forat  
Round fun noodles with hole

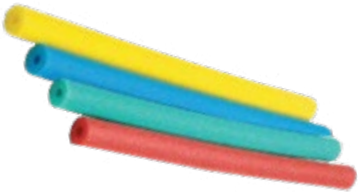

2004



Ø 9x100 cm.  
Fritas Maxi  
Frites Maxi  
Maxi fun noodles



2200



Conector sencillo  
Connector senzill  
Simple connector



2201



Conector medio  
Connector mitjà  
Medium connector



2202



Conector doble  
Connector doble  
Double connector



2302



Conector balsa 2 agujeros  
Connector bassa 2 forats  
2 Hole raft connector



2302-A



Conector balsa 2 agujeros Aquafoam  
Connector bassa 2 forats Aquafoam  
Aquafoam 2 hole raft connector



2307



Conector balsa 7 agujeros  
Connector bassa 7 forats  
7 Hole raft connector





3000



90x63x3 cm.  
Tapiz flotante mano  
Tapís flotant mà  
Hand floating playraft



3001



97x48x3 cm.  
Tapiz flotante pie  
Tapís flotant peu  
Foot floating playraft



3002



96x55x3 cm.  
Tapiz flotante fantasma  
Tapís flotant fantasma  
Ghost floating playraft



3003



95x52x3 cm.  
Tapiz flotante ballena  
Tapís flotant balena  
Whale floating playraft



3004



96x56x3 cm.  
Tapiz flotante cangrejo  
Tapís flotant cranc  
Crab floating playraft

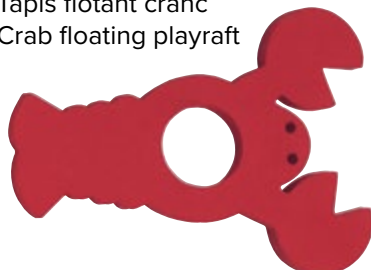

3005



93x54x3 cm.  
Tapiz flotante elefante  
Tapís flotant elefant  
Elephant floating playraft



3006



95x57x3 cm.  
Tapiz flotante dinosaurio  
Tapís flotant dinosaure  
Dinosaur floating playraft



3007



48x43x3 cm.  
Tapiz flotante nube  
Tapís flotant núvol  
Cloud floating playraft



3008



80x45x3 cm.  
Tapiz flotante ocho  
Tapís flotant vuit  
Eight floating playraft



3009



56x40x3 cm.  
Tapiz flotante pez  
Tapís flotant peix  
Fish floating playraft



3010



41,5x38x8 cm.  
Tapiz flotante caballo de mar  
Tapís flotant cavall de mar  
Seahorse floating playraft



3011



46x34,5x8 cm.  
Tapiz flotante foca  
Tapís flotant foca  
Seal floating playraft



4000



Ø 100x3 cm.  
Tapiz flotante circular  
Tapís flotant circular  
Circular floating playraft



4030/4042



Tapiz relajación circular  
Tapís relaxació circular  
Circular relaxation playraft  
4030: 100x30 Ø Interior cm.  
4042: 100x42 Ø Interior cm.



4002→4004/4007



Tapiz suave  
Tapís suau  
Soft playraft  
4002: 200x100x2 cm.  
4003: 200x100x3 cm.  
4004: 200x100x4 cm.  
4007: 200x100x7 cm.



4005/4010



Tapiz flotante  
Tapís flotant  
Floating playraft  
4005: 100x150x3 cm.  
4010: 200x150x3 cm.



4009/4011/4012



Tapiz multifunción  
Tapís multifunció  
Multifunction playraft  
4009: 11 agujeros  
150x100x4 cm.  
4011: 11 agujeros  
150x100x7 cm.  
4012: 12 agujeros  
200x100x7 cm.

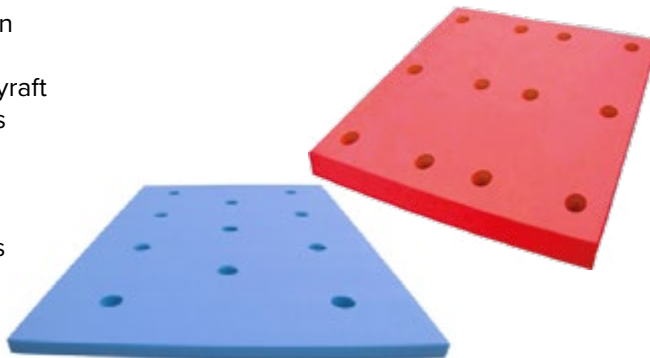

CONSÚLTANOS SOBRE  
TAPICES A MEDIDA  
CONSULTA'NS SOBRE  
TAPISSOS A MIDA  
ASK US ABOUT OUR CUSTOM  
MADE PLAYRAFTS

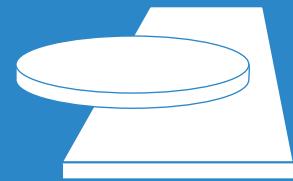

4200



150x50x8 cm.  
Puente flotante  
Pont flotant  
Floating bridge



4014/4015/4016



Tapiz bebé con orificios  
Tapís bebé amb forats  
Baby playraft with holes

4014: 100x50x2 cm.  
4015: 150x100x2 cm.  
4016: 200x100x2 cm.



4020/4022 

Tapiz cesta/Tapís cistella

Basquet playraft

4020: 100x100x6 cm.  
4030: 200x100x6 cm.



Ref.	Alfombra infinita Tapís infinit Infinity playraft	Tamaño (mts.)	Grosor (cm.)
4306	Junior	6x1,5	4
4308	Junior	8x1,5	4
4312	Junior	12x1,5	4



5000



Básquet acero inox.  
Bàsquet acer inox.  
Basket stainless steel



5001



Básquet acero inox. plegable  
Bàsquet acer inox. plegable  
Folding basket stainless steel



5002



Básquet con anclaje  
Bàsquet amb ancoratge  
Basket with anchorage



5102/5104



Voley flotante aluminio  
Voley flotant alumini  
Floating voley stainless steel  
5102: 2 m. largo  
5104: 4 m. largo



5200



90x70x60 cm.  
Portería waterpolo flotante  
Porteria waterpolo flotant  
Floating waterpolo goal



5300



230x80x60 cm.  
Tobogán poliéster y fibra vidrio  
Tobogan polièster i fibra vidre  
Polyester and fiberglass slide



5310



100x65x50 cm.  
Tobogán espuma infantil  
Tobogan escuma infantil  
Children's foam slide



5315



150x100x50 cm.  
Tobogán espuma junior  
Tobogan escuma Junior  
Junior's foam slide



6000



4 uds.  
Juego animales flotantes  
Joc animals flotants  
Floating animal pack



6001



6 uds.  
Juego cubos flotantes  
Joc cubs flotants  
Floating cube pack



6002/6003



Juego cilindros/Joc cilindres/  
Floating cylinders

6002: 6 uds.  
Grandes/Grans/Big

6003: 8 uds.  
Pequeños/Petits/Small



6004



Juego puzzle animales  
Joc puzzle animals  
Animal puzzle game



6005



Barco 5 animales flotantes  
Vaixell 5 animals flotants  
5 Animal floating ship



6006



6 Discos sumergibles numerados  
6 Discos submergibles numerats  
6 Numbered submersible discs



6007



4 Peces sumergibles  
4 Peixos submergibles  
4 Submersible fish

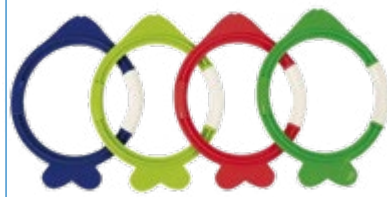

6008



40 largo x 30 Ø cm.  
Gusano flotante  
Cuc flotant  
Floating worm



6009



50 x 45 Ø cm.  
Herradura flotante  
Ferradura flotant  
Floating horseshoe



6010



Cubos para juegos acuáticos  
Galledes per a jocs aquàtics  
Pails for acuatic games



6011



Regaderas para juegos acuáticos  
Regadora per a jocs aquàtics  
Water can for acuatic games



6100



3 uds. Ø 70 cm.  
 Juego aros slalom 3 alturas  
 Joc cercles slalom 3 altures  
 3 Level slalom hoops pack

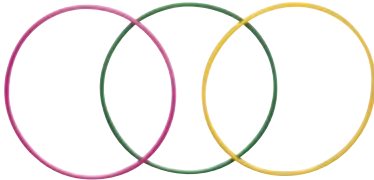

6101



5 uds.  
 Juego bastones de buceo  
 Joc bastons de busseig  
 Diving sticks pack



6102



5 uds. Ø 20 cm.  
 Juego aros sumergibles  
 Joc cercles submergibles  
 Submergible hoops pack



6103



Juego túnel de buceo  
 Joc túnel busseig  
 Diving tunnel pack



6104



Arcos de buceo  
 Arcs de busseig  
 Diving arches



6200



Alteras mango aluminio  
 Alteres mànec alumini  
 Stainless steel swimbars



6400/6401



Pelotas PVC transparentes  
 Pilotes PVC transparents  
 Transparent PVC balls  
 6400: Ø 14  
 6401: Ø 22 cm.



6402



Ø 22 cm.  
 Pelotas masaje  
 Pilotes massatge  
 Massage balls



6403



Ø 22 cms.  
 Pelotas rugosa  
 Pilotes rugoses  
 Rough balls



6404/6405



Pelotas gigantes  
 Pilotes gegants  
 Giant balls  
 6404: Ø 65 cm.  
 6405: Ø 85 cm.



# NATACIÓN

Pag.	NATACIÓN	NATACIÓ	SWIMMING
16	Gorros	Casquets	Caps
17	Gafas	Ulleres	Goggles
18-19	Aletas	Aletes	Fins
20	Complementos	Complements	Complements



11001/11002 

Látex  
11001: Adulto/Adult 11002: Infantil/Junior



11009 

Silicona  
11009: Clasic



Surtido de colores a elegir

11011 

Silicona multicolor



11020 

Lycra



11030 

Poliéster



11040 

Race  
Rojo, Azul, Blanco, Negro  
Vermell, Blau, Blanc, Negre  
Red, Blue, White, Black



11050 

Bubble Cap



11101	11102	11103	11104	11105
Serigrafía 1ª Impresión	Serigrafía 2ª Impresión	Serigrafía 3ª Impresión	Serigrafía 4ª Impresión	Pantalla y Fitolito



12000



Tubo respiración Lud  
Tub respiració Lud  
Breathing tube Lud



12001



Right



12002



Burbujita



12003/12004



12003: Dual gafas/ulleres  
goggles  
12004: Mirror gafas/ulleres/  
goggles



12005



Gafas natación Sidney  
Ulleres natació Sidney  
Sidney swimming goggles



12006



NEW DESIGN

Gafas natación Flexi  
Ulleres natació Flexi  
Flexi swimming goggles



12007



NEW DESIGN

Gafas natación Marni  
Ulleres natació Marni  
Marni swimming goggles



12008



Gafas natación Colmar SR  
Ulleres natació Colmar SR  
Colmar SR swimming goggles



12009



NEW DESIGN

Gafas natación Via  
Ulleres natació Via  
Via swimming goggles



12010



Right Junior



12011



Burbujita infantil  
Burbujita junior



12012



Gafas natación Colmar infantil  
Ulleres natació Colmar infantil  
Junior Colmar swimming  
goggles



Aleta Corta Light  
Aleta Curta Light  
Light Short Fin



Ref.	Talla/Size
13000	31-32
13001	33-34
13002	35-36
13003	37-38
13004	39-40
13005	41-42
13006	43-44
13007	45-46

Aleta Corta Light: recomendadas para entrenamiento tanto en piscinas como en aguas abiertas.  
Fabricadas en polipropileno muy resistente y muy flexibles en su conjunto



Aleta Corta Silicona  
Aleta Curta Silicona  
Silicone Short Fin



Ref.	Talla/Size
13100	31-32
13101	33-34
13102	35-36
13103	37-38
13104	39-40
13105	41-42
13106	43-44
13107	45-46
13108	47-48

Surtido de colores según disponibilidad.

Aletas de pala corta **silicona**, cómodas y muy resistentes.  
Tamaño ideal para entrenamiento, aquafitness y rehabilitación.



Clio



Ref.	Talla/Size
13200	27-29
13201	30-32
13202	33-34
13203	35-36
13204	37-38
13205	39-40
13206	41-42
13207	43-44
13208	45-46

Aletas muy polivalentes con pala fabricadas en EVA de bajo módulo. Flexible, resistente y muy flexible. Diseño anatómico y talón fabricado en elastómero de alta calidad



Dardo  
100% Caucho/Cautxú/Rubber



Ref.	Talla/Size	Color/Colour
13300	26-29	
13301	30-33	
13302	34-35	
13303	36-37	
13304	38-39	
13305	40-41	
13306	42-43	
13307	44-45	
13308	46-48	



Dardo: Las más clásicas y también las más vendidas, ya sea porque están fabricadas en **goma natural con talón cerrado, como por su comodidad y durabilidad.**

**Disponen de una pala media para entrenamiento en piscina.** Mayor rigidez, el uso de mayor cantidad de goma natural en su fabricación disminuye la flexibilidad (sobre todo en el talón) de las aletas e incrementa su durabilidad.

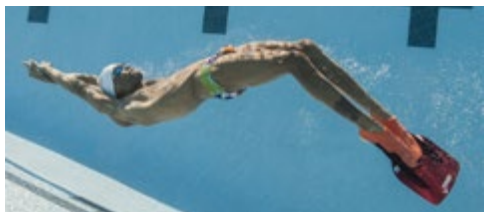

13600/13601

Monofin Shooter  
13600: M  
13601: L



Aleta Corta Flexible Ocean  
Aleta Curta Flexible Ocean  
Ocean Flexible Short Fin

Ref.	Talla/Size
13500	26-29
13501	30-33
13502	34-35
13503	36-37
13504	38-39
13505	40-41
13506	42-43
13507	44-45
13508	46-48

14000



14000: T. 35→46  
Chancla/Xancleta Piscina Lux./  
Lux. Swimming Pool Flip-Flops



14020



T. 36→46  
Chancla Piscina Ralph  
Xancleta Piscina Ralph  
Ralph Swimming Pool Flip-Flops



14030



Zapatilla Silicona T 35→46



14200



Cubre Zapatos  
Cubre Sabates  
Shoe Cover



14040/14041



Calcetín/Mitjó/Sock Látex  
14040: T. 0-3 23-25/32-34  
14041: T. 4-7 35-37/46



14050/14051



Calcetín/Mitjó/Sock Olosocks  
14050: Pink T. 22/23→40/41  
14051: BlueT. 22/23→44/45



14060



Pinzas Nariz Profesional  
Pincas Nas Professional  
Professional Noseclip



14061



Pinzas Nariz Clip Metal  
Pincas Nas Clip Metal  
Metal Noseclip



14062



Pinzas Deluxe  
Pincas Deluxe  
Deluxe Clips

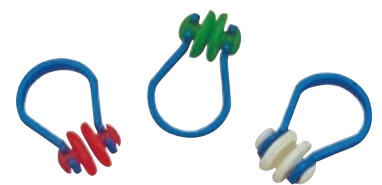

14063

4 Uds.  
Tapones Oído Silicona  
Taps Orelles Silicona  
Silicone Ear Plugs



14070



100 Uds.  
Distintivo Cursillo Delfín  
Distintiu Curset Dolfi  
Dolphin Emblem Badge



14071



100 Uds.  
Distintivo Cursillo Caballito  
Distintiu Curset Cavallet  
Sea Horse Emblem Badge



# ENTRENAMIENTO

Pag.	ENTRENAMIENTO	ENTRENAMENT	TRAINING
22	Pull-buoy	Pull-buoy	Pull-buoy
23	Manoplas y guantes	Manoples i guants	Handpaddles & gloves
24-28	Aquagym y complementos	Aquagym i complementes	Aquagym & complements



7000



23x12x8 cm.  
Pull-Buoy Tri Termoconformado



7001



23x12x8 cm.  
Pull-Buoy Monobloc



7002



23x10x8 cm.  
Pull-Buoy Monobloc Infantil



9000/9001



28x20 cm.  
9000: Tabla Na-do  
9001: Tabla Na-do con  
pinturas/amb pintures/with  
colours



9100



47x28 cm.  
Icolen Grande  
Icolen Gran  
Big Icolen



9101



39x23 cm.  
Icolen Mediana  
Icolen Mitjà  
Medium Icolen



9102



29x22 cm.  
Icolen Pequeña  
Icolen Petita  
Small Icolen



9103



47x28 cm.  
Icolen Eurokick  
Icolen Eurokick  
Eurokick Icolen



9104



38x28 cm.  
Icolen Sport  
Sport Icolen



9200



57x32x4 cm.  
Triathlon



9201



32x29x5 cm.  
Tabla Pull Kick



8000/8001/8002



Manopla anatómica  
Anatomic hand paddle  
8000: S  
8001: M  
8002: L



800

Recambio/Recanvi/Spare Part  
Manopla anatómica y Profi  
Manopla anatómica i Profi  
Hand paddle



8010/8011/8012



Manopla Profi  
Profi hand paddle  
8010: S  
8011: M  
8012: L

8020/8021



Palas de natación sin goma  
Pal·las de natació sense goma  
Swimming hand paddles without band  
8020: M  
8021: L



8100/8101/8102



Guante membrana  
Guant membrana  
Membrane glove  
8100: S  
8101: M  
8102: L



8200



Guante membrana neopreno  
Guant membrana neoprè  
Neoprene membrane glove  
8,5x25 cm.  
Talla única  
One size



8210/8220/8230



Guante membrana neopreno  
dedo cerrado  
Guant membrana neoprè dit  
tancat  
Closed finger neoprene  
membrane glove  
8210: S  
8220: M  
8230: L



10100



Alter Gym Triangular

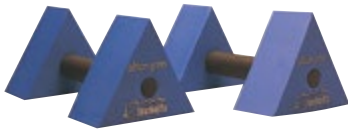

10101



Cuadrado/Quadrat/Square  
Alter Gym

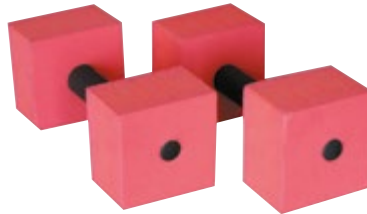

10102



Redondo/Rodó/Round  
Alter Gym



10000/111



10000: 68x28x3 cm.  
Cinturón Pool Gym  
Cinturó Pool Gym  
Pool Gym Belt  
111: Recambio/Recanvi  
Spare Part



10300



Foot Gym



10200



Aqua Boxing



10310



Ajustable/adjustable  
Muñequeras/Tobilleras Acuáticas  
Canelleres/Turmelleres Aquàtiques  
Aquatic Bracelets/Ankle



10500/10501



Muñequeras/Tobilleras Acuáticas  
Canelleres/Turmelleres Aquàtiques  
Aquatic Bracelets/Ankle  
10500: 0,50 kgs.  
10501: 1 kg.





10400



Powerstick 75 cm.



10401



Betomic



10402



Universal Ring



10403



Aquadisc



10404



Beflex



10405



Dynafloat



10406



Beco Twin

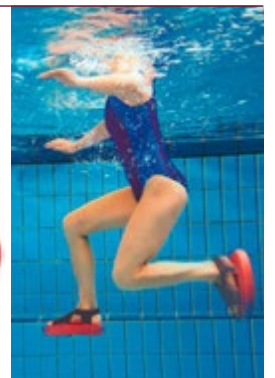

10800



### Aqua Bike WR20

La Nueva WR20 está fabricada en Aluminio T6 con Marco Anodizado, lo que le da una mayor durabilidad y ligereza, igualmente incluye Sistema de Resistencia Hidráulica a través de palas y los nuevos pedales Aqua Double Speed que pueden incrementar la resistencia hasta más de un 50%. Finalmente, sus ruedas delanteras hacen que sea muy fácil manejo dentro y fuera del agua.



10801



Aqua Bike Eagle para aquellos que quieren combinar el ejercicio cardiovascular con el entrenamiento de fuerza.

Resistencia Hidráulica mediante sistema de palas que se pueden rotar manualmente.



10802



### Aqua Bike Alulo

Nuevo sistema de pedales Aqua Double Speed que ofrecen un incremento de la resistencia en el pedaleo hasta más de un 50% con un simple gesto. Su marco de aluminio anodizado reduce el peso por debajo de los 10 kilos y su nuevo sillín ergonómico que resulta más cómodo.



10803



### Aqua Bike Veracruz

Es la bicicleta acuática más avanzada del momento, su resistencia progresiva y su pedal anatómico para ser usado sin calzado destacan como los elementos más innovadores.

Modelo destinado a uso profesional intenso, su estructura principal ultra reforzada está indicada para personas de más 1,90 y 90 kg. de peso. Se suministra con porta bidón para la hidratación del usuario.



10804



Elevador Aqua Bikes  
Facilita la entrada y salida de las aquabikes en la piscina, como también su almacenamiento.



10810  

Aqua Run Inox



10811 

Aqua Run aluminio/alumini/aluminium

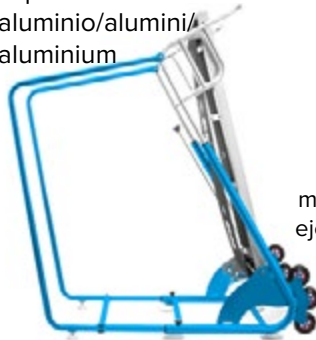

El Aqua Run combina los beneficios de la flotabilidad del agua con los de la marcha o el running gracias a la fluidez de movimiento. Trabaje a su propio ritmo y fortalezca los músculos, mejore la resistencia y realice ejercicios de rehabilitación de manera segura gracias a su excelente estabilidad.



10813



Aqua Mat

Diseñado para permitir que todas las piscinas ofrezcan una nueva actividad acuática, sin restricción de la profundidad del agua permitiendo realizar ejercicios de YOGA, PILATES y HIT



10814



Plataforma Circular Instructor

La plataforma permite alcanzar hasta 10 poolmats y realizar la sesión a 10 clientes.



10820



Tramp Redondo



10815

Plataforma Rectangular.  
Capacidad 12 tablas  
305x183x15 cm.



10830



Aqua Eliptic

Aparato de ejercicio completo y sencillo de utilizar que combina los beneficios del remo, el esquí de fondo, el step y la bicicleta.

Con ella se pueden trabajar todos los músculos del cuerpo a la vez.

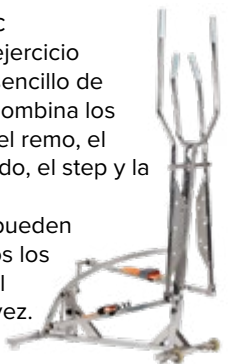

10840



Pool Training

Piscina desmontable que combina la simplicidad de la instalación de spa con equipos de gimnasia acuática.



6200



Alteras  
Aletes  
Polyvalent swimbar

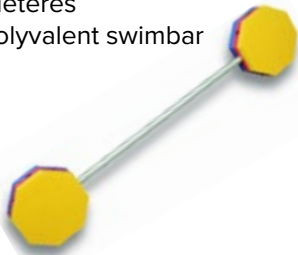

6201



Barbell Multitrainer  
100xØ 8 cm.



10701/10702/10703



Cinta látex training band  
10701: 0,35 mm.x15x140 cm.  
10702: 0,50 mm.x15x140 cm.  
10703: 0,65 mm.x15x140 cm.



10700



Cinturón de resistencia  
Cinturó de resistència  
Resistance belt



10707



Paracaídas resistencia  
Paracaigudes resistència  
Parachute belt



21600



75x45x200  
Carro transporte 10 steps  
10 Steps transport trolley



10600



68x40x14/19 cm.  
Step Acuático/Aquàtic/Water Step  
Altura regulable/adjustable height



106-1

Recambio ventosa step  
Recanvi ventosa step  
Suction step spare part  
Producto antiguo/antic/old model



10706



Balance floor



# EQUIPAMIENTO

Pag.	EQUIPAMIENTOS	EQUIPAMENTS	EQUIPMENT
30-33	Líneas de flotación	Línies de flotació	Swimming lanes
34	Anclajes	Ancoratges	Anchorage
35	Podiums	Podiums	Podiums
36-37	Competición	Competició	Competition
38-39	Waterpolo	Waterpolo	Waterpolo
40	Rejillas	Reixetes	Grids
41	Escaleras y duchas	Escales i dutxes	Ladders & showers
42-43	Elevadores	Elevadors	Lifts
44-45	Salvamento	Salvament	S.O.S.
46-47	Relojes	Rellotges	Clocks
48-55	Equipamentos de instalación	Equipaments d'instalació	Facility equipment
56-57	Cubiertas y enrolladores	Cobertes i enrotlladors	Covers & winches
58-59	Equipamiento piscina	Equipament piscina	Swimming pool facilities



Roma Línea Flotación/Línea Flotació/Flotation Lane



Ref.	Tamaño/ Tamany/Size	Cuerda/ Corda/Rope	Cable	Mosquetón Mosquetó/Hook
15000	x metro	Si	No	No
15000C	x metro	No	Si	No
15025	25 mts.	Si	No	Si
15050	50 mts.	Si	No	Si
15025C	25 mts.	No	Si	Si
15050C	50 mts.	No	Si	Si



Moscú Línea Flotación/Línea Flotació/Flotation Lane

Ref.	Tamaño/ Tamany/Size	Cuerda/ Corda/Rope	Cable	Mosquetón Mosquetó/Hook
15100	x metro	Si	No	No
15100C	x metro	No	Si	No
15125	25 mts.	Si	No	Si
15150	50 mts.	Si	No	Si
15125C	25 mts.	No	Si	Si
15150C	50 mts.	No	Si	Si



Gran Moscú Línea Flotación/Línea Flotació/Flotation Lane

Ref.	Tamaño/ Tamany/Size	Cuerda/ Corda/Rope	Cable	Mosquetón Mosquetó/Hook
15200C	x metro	No	Si	opcional
15225C	25 mts.	No	Si	Si
15250C	50 mts.	No	Si	Si



15501



Roma  
Flotador/Floating  
Ø 80 mm.



15502



Moscú  
Flotador/Floating  
Ø 100 mm.



15503



Gran Moscú  
Flotador/floating  
Ø 150 mm.



15170/15270



Señalización calle  
Senyalització carril  
15170: Moscú  
15270: Gran Moscú

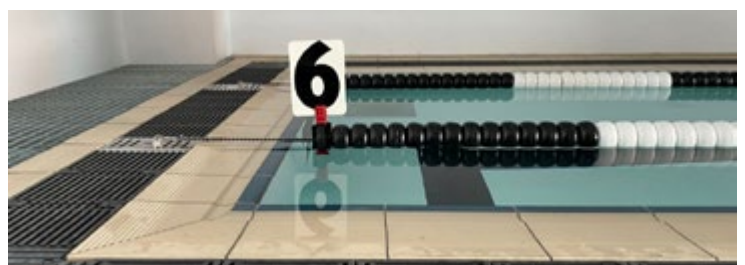

15325/15350

INOX

Cable de acero/acer inox.  
Stainless steel cable  
15325: 25mts. Ø 3m/m  
15350: 50 mts. Ø 3m/m  
15425: 25mts. Ø 4m/m  
15450: 50mts. Ø 4m/m



15325F/15350F

INOX

Cable de acero inox. forrado  
Cable de acer inox. folrat  
Lined stainless steel cable  
15325F: 25 mts.  
15350F: 50 mts.



15400

Mt. Lineal  
Cuerda especial líneas flotación  
Corda especial línies flotació  
Special flotation lane rope



16000/16001



INOX

Tensor especial para cable  
Tensor especial per a cable  
Special tensor for cable  
16000: Azul  
16001: Rojo



160A: Funda azul/blau/blue  
161R: Funda rojo/vermell/red

16100/16792/16701

INOX

16100: Tensor de rosca  
Thread tensioner



16792: S Gancho/Ganxo/Hook



16701: Mosqueton/Mosquetó/  
Snap hook



15600

INOX

Recoge corcheras suelo  
Recull sureres sol  
Floor flotation lanes winch



16200

INOX

Muelle estabilizador electropulido  
Moll estabilitzador electropullit  
Electropolished stabilizer spring



16201

Protección Muelle Estabilizador  
Protecció moll estabilitzador  
Stabilizer spring protector  
130 mm. x Ø 100 mm.



15601

Recoge corcheras de superficie  
Recull sureres de superficie  
Flotation lane slider



16390

Carro corcheras/Carro sureres/  
Flotation lane trolley  
100x70x80 cm.



16320/16380

INOX

Enrollador línea flotación  
Enrotllador línia flotació  
Flotation lane winch



Corchera Surera Lane	16320 1,20 mt.		16380 1,80 mt.	
	25 mt.	50 mt.	25 mt.	50 mt.
Roma	8	4	12	6
Moscú	4	2	6	3
Gran Moscú	2	1	3	1

## ROMA

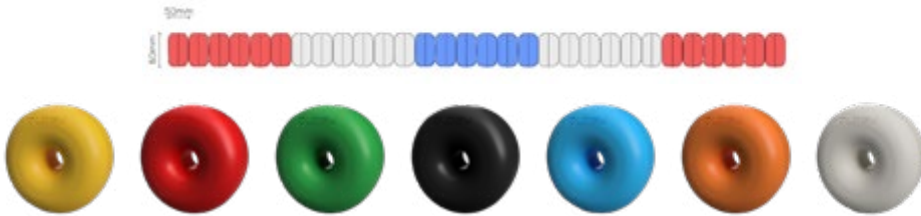
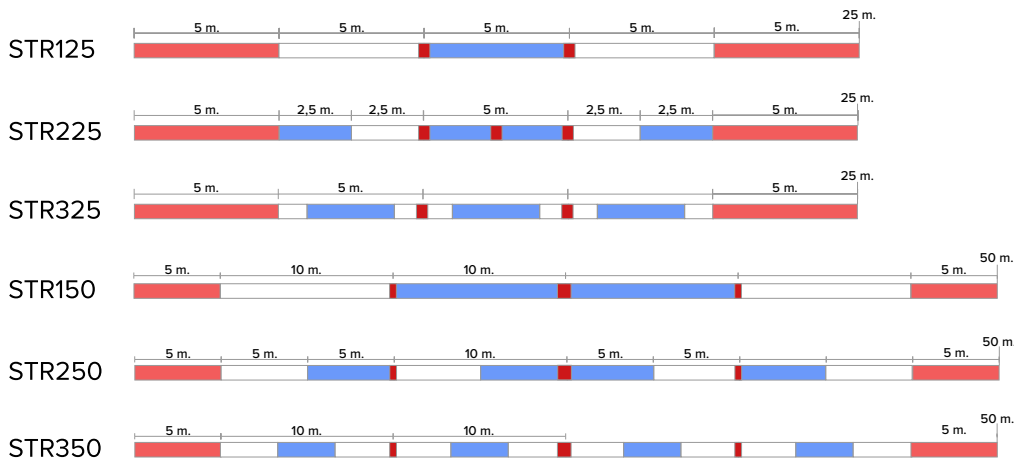

**PERSONALIZACIÓN:**

Opción personalización de colores y longitud  
 Opció de personalització de colors i longitud  
 Length and color personalization option

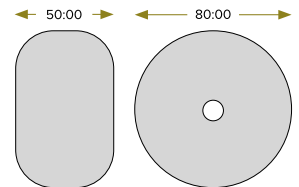

## MOSCÚ

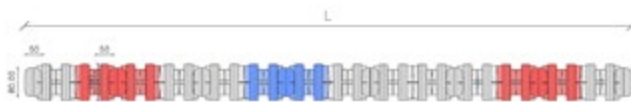
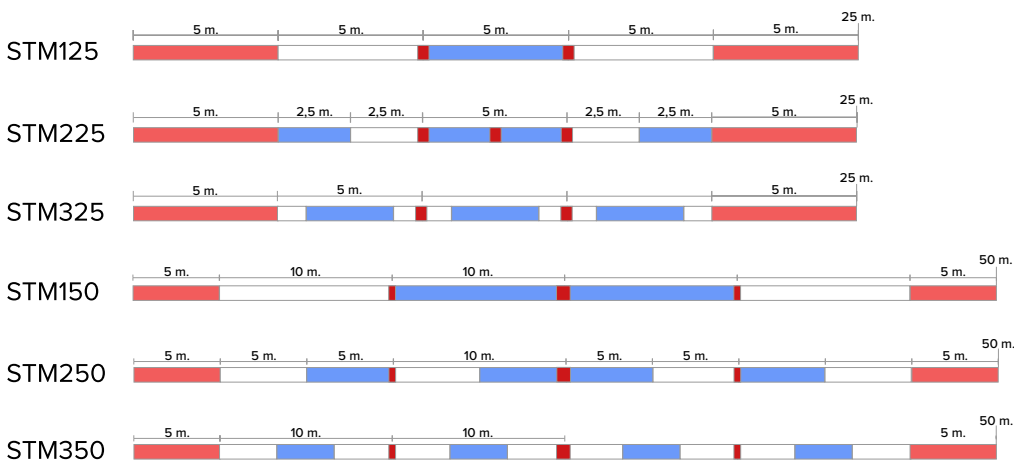

**PERSONALIZACIÓN:**

Opción personalización de colores y longitud  
 Opció de personalització de colors i longitud  
 Length and color personalization option

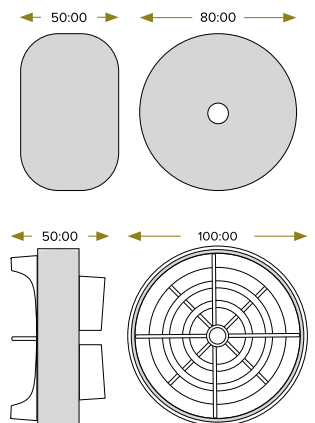



## 15225C Corchera Gran Moscú 25 m.

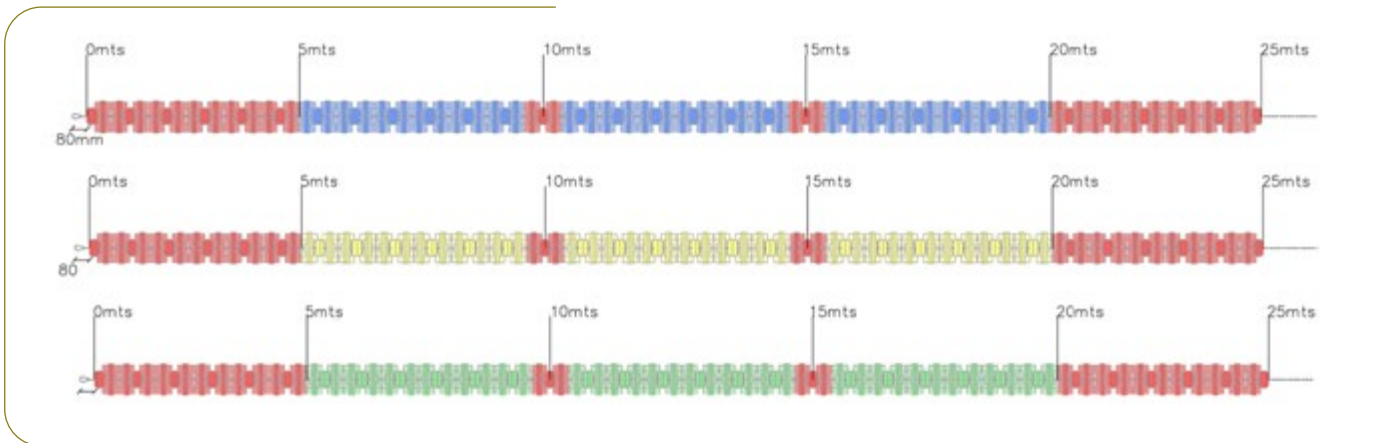

## 15250C Corchera Gran Moscú 50 m.

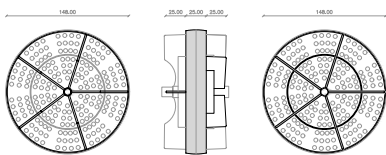
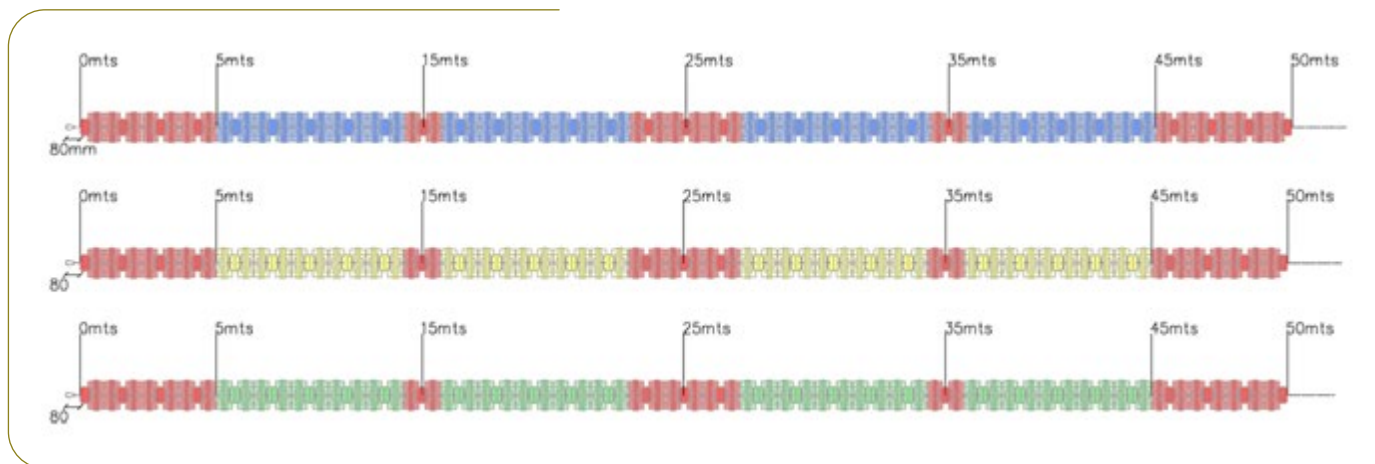

Montaje según normativa FINA

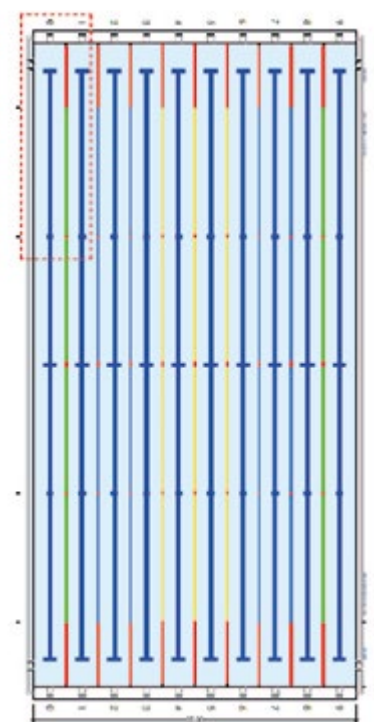
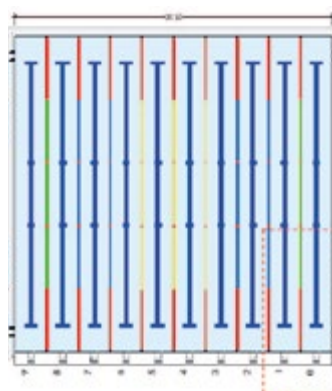
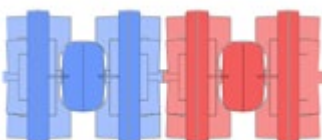
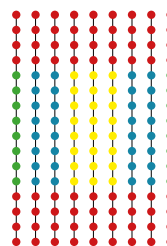

### PERSONALIZACIÓN:

Opción personalización de colores y longitud  
 Opció de personalització de colors i longitud  
 Length and color personalization option

16400 Ø 43 mm. INOX

Anclaje tintero con tapa  
Ancoratge tinter amb tapa  
Inkwell anchor with lid



16401 Ø 43 mm. INOX

Soporte bayoneta  
Suport baioneta  
Bayonet bracket



16402 Ø 43 mm. INOX

Anclaje bayoneta  
Ancoratge baioneta  
Bayonet anchorage



16402-F Ø 43 mm. INOX

Anclaje inclinado finlandés  
Ancoratge inclinat finlandès  
Finnish slanting anchorage



16403 Ø 43 mm. INOX

Anclaje tipo copa  
Ancoratge tipus copa  
Cup anchorage



16404 Ø 30 mm. INOX

Anclaje con cadena  
Ancoratge amb cadena  
Anchorage with chain



16501 Ø 30 mm. INOX

Anclaje 1 alojamiento  
Ancoratge 1 allotjament  
Anchorage 1 lodging



16600 INOX

Anclaje tipo caja  
Ancoratge tipus caixa  
Anchorage box style



17850 INOX

Base anclaje podium



16700/16800 INOX

16700  
Anclaje rosca  
Ancoratge rosca  
Threaded anchorage



16800  
Tornillo expansión podium  
Cargol expansió podium  
Podium expansion screw



17000PE INOX

Plataforma elevada  
Elevated platform



17000PM INOX

Puente móvil manual o motor  
Pont mòbil manual o motor  
Mobile bridge manual or motor

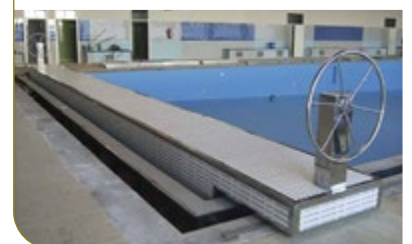

17400C/17500C

INOX

17400C: 400 mm./17500C: 500 mm.  
Podium salida columna cuadrada  
Podium surtida columna quadrat  
Start podium square column



17400R/17500R

INOX

17400R: 400 mm./17500R: 500 mm.  
Podium salida columna redonda  
Podium surtida columna rodona  
Start podium round column



17800PLF/17000PL

INOX

17800PLF  
Plataforma competición 5 pos.  
5 Position competition platform  
Fibra/Fibre/Fiber 700x500 mm.



17000PL Plataforma  
antideslizante  
500x500 mm.



17800F

INOX

Podium comp. 7 posiciones  
Podium comp. 7 posicions  
7 Position. comp. podium  
Fina Norms.



17801F

INOX

Podium comp. 7 posiciones  
Podium comp. 7 posicions  
7 Position. comp. podium  
Colm. cuadrada/cuadrat/square  
Fina



17800FF

INOX

Podium competición 5 pos.  
Podium competició 5 pos.  
5 Position competition podium  
Fibra/Fibre/Fiber

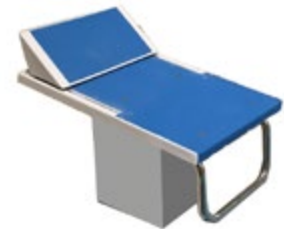

17700

INOX

700 mm.  
Podium salida peldaño  
Podium surtida esglaó  
Start podium step



17700CF

INOX

Podium competición 700 5 pos.  
Podium competició 700 5 pos.  
700 5 Position competition  
podium Fibra/Fibre/Fiber



17800PL

INOX

Plataforma antideslizante 7 pos.  
7 pos. antislip platform.  
Politileno. 700x500 mm.



17000

INOX

Salida competición espalda pro  
Sortida competició esquena pro  
Pro backstroke competition start



17000SE

INOX

Salida espalda competición  
Surtida esquena competició  
Competition backstroke start



17900

INOX

Adaptador podium competición  
Adaptador podium competició  
Competition podium converter



17200/17201/17202/17203

INOX



Placa de giro inox-PVC  
Placa de gir inox-PVC  
Stainless steel-PVC  
Turning plate

17200: 200x18,5 cm.  
17201: 200x30 cm.  
17202: 250x30 cm.  
17203: 250x18,5 cm.

17100/17101/17102/17103

INOX

Placa de giro inox.  
Placa de gir inox.  
Stainless steel  
Turning plate



17100: 200x30 cm.  
17101: 200x18,5 cm.  
17102: 250x30 cm.  
17103: 250x18,5 cm.

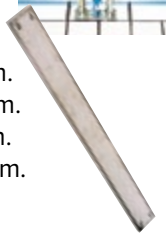

16603

INOX

Soporte especial doble  
Suport especial doble  
Double special bracket



16604

INOX

Soporte especial individual  
Suport especial individual  
Individual special bracket



17310/17320

INOX

Pared viraje/Paret viratge  
Turning wall  
17310: 200x110 cm.  
17320: 250x110 cm.



16605

INOX

Soporte corto  
Suport curt  
Short Support  
Soporte especial placa giro  
Suport especial placa gir  
Special bracket turning plate



16606

Soporte largo  
Soporte cuando L > a 50 cm.  
Para placas 2 m. 2 soportes  
Placas de 2,5 m. 4 soportes  
Suport quan L > a 50 cm.  
Per a plaques 2 m. 2 suports  
Plaques de 2,5 m. 4 suports  
Suport when L > to 50 cm.  
For plates 2 m. 2 suports  
Plates 2,5 m. 4 suports

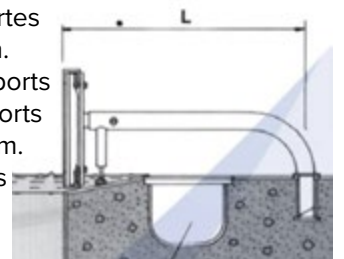

16502

Ø 32 mm.

INOX

Anclaje 2 alojamientos  
Ancoratge 2 allotjaments  
Anchorage 2 lodgings



16503

INOX

Anclaje 3 alojamientos  
Ancoratge 3 allotjaments  
Anchorage 3 lodgings



16601/16602

INOX

Soporte placas de giro  
Suport placa de gir  
Turning plate bracket  
16601: 300 m/m  
16602: 185 m/m



17012ESP/17016ESP  
17021ESP/17025ESP

INOX

Postes señalización espalda completos  
Postes senyalització esquena complets  
Marking full back poles

17012ESP: 12,50 m.  
17016ESP: 16,66 m.  
17021ESP: 21,00 m.  
17025ESP: 25,00 m.



17012SF/17016SF  
17021SF/17025SF

INOX

Postes salidas falsas completos  
Postes surtides falses complets  
Complete false start poles

17012SF: 12,50 m.  
17016SF: 16,66 m.  
17021SF: 21,00 m.  
17025SF: 25,00 m.



17012GP/17016GP  
17021GP/17025GP

17012GT/17016GT  
17021GT/17025GT

Juego gallardetes plástico/plàstic

17012GP: 12,50 m.  
17016GP: 16,66 m.  
17021GP: 21,00 m.  
17025GP: 25,00 m.

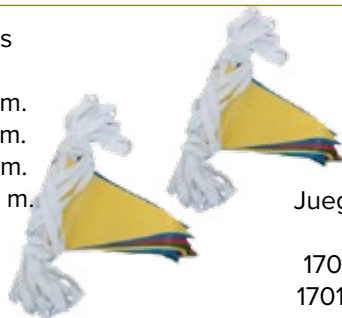

Juego gallardetes tela/fabric

17012GT: 12,50 m.  
17016GT: 16,66 m.  
17021GT: 21,00 m.  
17025GT: 25,00 m.

17012FL/17016FL  
17021FL/17025FL

Flotadores salidas falsas  
Flotadors surtides falses  
False start floats

17012FL: 12,50 m.  
17016FL: 16,66 m.  
17021FL: 21,00 m.  
17025FL: 25,00 m.

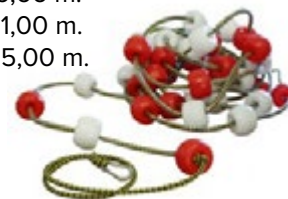

17100

INOX

Placa marcación profundidad  
Placa marcació profunditat  
Depth marking plate  
150x100x1,5 mm. (posibilidad de personalizar)

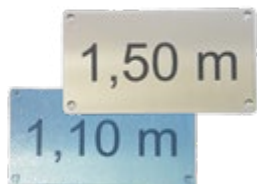

170PA

INOX

180 cms. Ø 43 mm.  
Poste con anilla  
Pal amb anella  
Post with ring

Opcional Ø 48 mm.



170PP

INOX

180 cms. Ø 43 mm.  
Poste con polea  
Pal amb corriola  
Post with pulley

Opcional Ø 48 mm.



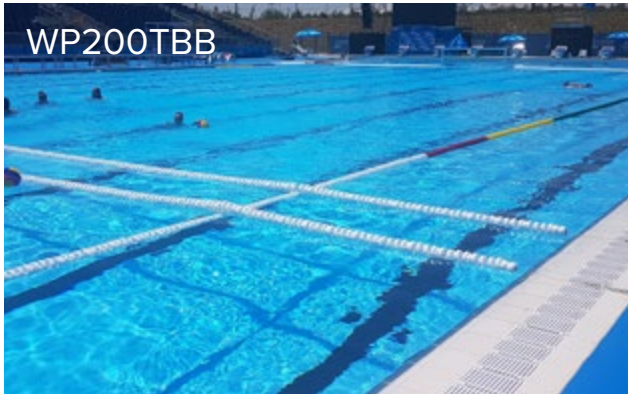

WP200TBB

**WP200TBB-MOSCÚ**

Líneas transversales 11 mt. color blanco  
 Línies transversals 11 mt. color blanc  
 Cross lanes 11 mt. white colour

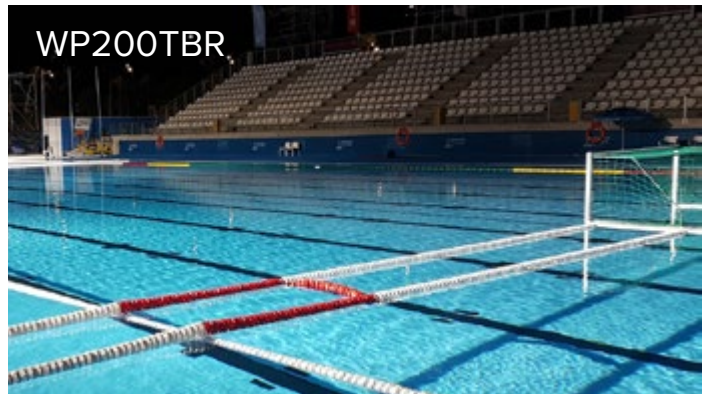

WP200TBR

**WP200TBR-MOSCÚ**

Líneas transversales 11mt. color blanco y zona castigo roja  
 Línies transversals 11mt. color blanc i zona càstig vermella  
 Cross lanes 11mt. white color and red punishment zone

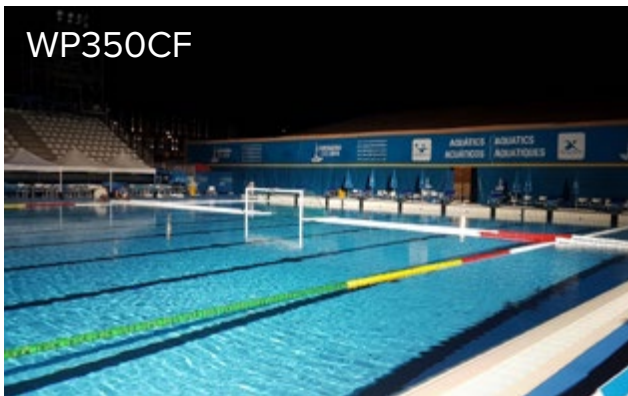

WP350CF

**WP350CF-MOSCÚ**

Líneas longitudinales campo femenino 50 mt.  
 (disposición colores según normativa Fina)  
 Línies longitudinals camp femení 50 mt.  
 (disposició colors segons normativa Fina)  
 Longitudinal lanes female field 50 mt.  
 (color arrangement according to Fina regulations)



WP350CM

**WP350CM-MOSCÚ**

Líneas longitudinales campo masculino 50 mt.  
 (disposición colores según normativa Fina)  
 Línies longitudinals camp masculí 50 mt.  
 (disposició colors segons normativa Fina)  
 Longitudinal lanes male field 50 mt.  
 (color arrangement according to Fina regulations)



**WP-MOSCÚ**

Campo Waterpolo comp. Moscú 50x25 m.  
 Inc. líneas y elementos de sujeción (no inc. porterías)  
 Camp competició Waterpolo Moscú 50x25 m.  
 Inc. línies i elements de sujecció (no inc. porteries)  
 Competition Waterpolo Moscú field 50x25 m.  
 Inc. lines & fastening elements (goals not included)

**WP-ROMA**

Campo Waterpolo entrenamiento Roma 50x25 m.  
 Inc. líneas y elementos sujeción (no inc. porterías)  
 Camp Waterpolo entrenament Roma 50x25 m.  
 Inc. línies i elements de sujecció (no inc. porteries)  
 Training Roma waterpolo field 50x25 m.  
 Inc. lines & fastening elements (goals not included)

**NOTA: Opción: Línea de flotación Roma, cable o cuerda / Opció: Línia de flotació Roma, cable o corda**  
**Option: Roma flotation line, cable or rope**

## WP3000

316x112x155 cm.  
Set porterías waterpolo Fina  
Set porteries waterpolo Fina  
Fina waterpolo goal set



## RED/NET

Recambio red/Recanvi red/  
Net spare part  
WP3000R: Fina  
WP1800R: Iniciación  
WP2500R: Alevín



## 16201B

130x Ø 100 mm.  
Protector muelle waterpolo  
Protector moll waterpolo  
Waterpolo dock protector



## WP22

Set Banderines waterpolo  
Set Banderoles waterpolo  
Waterpolo flags set  
8 ud.



## WP3100

Carro transporte porterías  
Carro transport porteria  
Goal transportation trolley  
150X35X10 cm.



## WP100



WP100:  
Saque central Competición  
Servei central competició  
Central competition kick



## WP33

Set 18 conos/cons/cones  
señalización campo waterpolo  
(2 blancos, 4 amarillos, 12 rojos)  
(2 blancs, 4 grocs, 12 vermells)  
(2 white, 4 yellow, 12 red)



## WP400S

Suelo antideslizante tarima  
àrbitros  
Sòl antilliscant tarima àrbitres  
Non-slippery referee catwalk

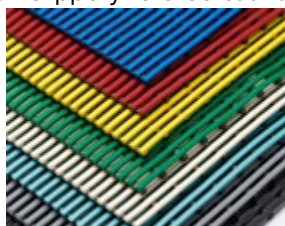

## WP1800/WP2500

Set porterías waterpolo  
Waterpolo goal  
WP1800: 180x90x100 Iniciación  
WP2500: 250x90x100 Alevín



## SP101/WP120

SP101:  
Saque central entrenamien  
Servei central entrenamer  
Central training kick



## WP30

WP120: Eye Let

Balón waterpolo caucho  
Pilota waterpolo cautxú  
Rubber waterpolo ball



## WP1R

## WP26SET→WP30SET

Gorros waterpolo  
Capells waterpolo  
Waterpolo caps  
WP1R: 1  
WP26SET: 26  
WP28SET: 28  
WP30SET: 30



19245L

23x245 mm. 4 uds. = 1mt.  
 Rejilla longitudinal con protección UV.  
 Compatible con alturas 22 y 24 mm.  
 Reixeta longitudinal amb protecció UV.  
 Compatible amb alçades 22 i 24mm.  
 Longitudinal grid with UV protection.  
 Compatible with 22 & 24 mm. hight.



Colores/Colors/Colours:  
 Blanco/Blanc/White  
 Gris antracita/anthracite gray  
 Personalización de color,  
 consultar

19245T

23x245 mm. 4 uds. = 1mt.  
 Rejilla transversal con protección UV.  
 Compatible con alturas 22 y 24 mm.  
 Reixeta transversal amb protecció UV.  
 Compatible amb alçades 22 i 24 mm.  
 Cross grid with UV protection.  
 Compatible with 22 & 24 mm. hight.



Nuestras rejillas han pasado los Ensayos de resistencia al deslizamiento por el método del péndulo de fricción.  
 Ensayo en húmedo. Superficies de tránsito peatonal. según la norma UNE 41901:2017 EX

MÓDULO REJILLA TRANSVERSAL PARA CURVAS

En PP con estabilizantes para la protección contra los rayos UV. 45 unidades por metro lineal.  
 En PP amb estabilizants per a la protecció contra els raigs UV. 45 unitats per metre lineal.  
 In PP with stabilizers for UV protection.  
 45 units per linear meter.



Ref.	Medidas
19010	22x195 mm.
19011	22x245 mm.
19012	22x295 mm.
19013	22x335 mm.
19020	35x195 mm.
19021	35x245 mm.
19022	35x295 mm.
19023	35x335 mm.



PLACA ESQUINERA 90°

Placas para esquinas de canal rebosadero de 90°.  
 Plaques per a cantonades de canal sobreixidor de 90°.  
 90° Overflow channel corner plates.



Ref.	Medidas
19100	22x195 mm.
19101	22x245 mm.
19102	22x295 mm.
19103	22x335 mm.
19200	35x195 mm.
19201	35x245 mm.
19202	35x295 mm.
19203	35x335 mm.

PLACA REJILLA TRANSVERSAL

En PP con estabilizantes para la protección contra los rayos UV. (5 unidades = 1 m).  
 En PP amb estabilizants per a la protecció contra els raigs UV. (5 unitats = 1 m).  
 In PP with stabilizers for UV protection. (5 units x 1 m).



Ref.	Medidas
19000	22x245 mm.
19001	22x295 mm.
19002	22x335 mm.



18000AS

AL

Pasamanos asimétrico  
Passamans asimètric  
Asymmetric handrail



18002/18003/18004

AL

Escalera estandar AISI 304  
Peldaños/esglaons/  
steps:  
18002: 2  
18003: 3  
18004: 4  
18005: 5



Option  
AISI 316

18800

AL

800x203  
Pasamanos para empotrar o pletina  
Passamans per empotrar o pletina  
Handrail to embed or plate

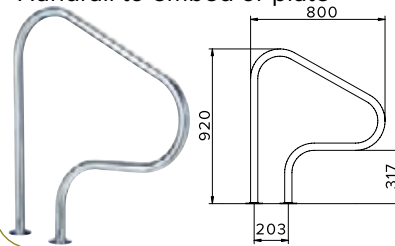

18490

AL

490x207  
Pasamanos partida  
Passamans partida  
Split handrail



18111/18121/18131/18141/18150

AL

Escalera partida inferior/Escala partida inferior/  
Lower split ladder  
Peldaños, esglaons, steps:  
18111: 2  
18121: 3  
18131: 4  
18141: 5  
18150: peldaño de seguridad  
Esglaó de seguretat  
Security step



D100FLUX

AL

Ducha estandar  
con fluxómetro  
Dutxa estàndar  
amb fluxometre  
Standard shower  
with fluxometer



18505→18507/18705→18707

AL

Escalera acceso fácil  
Escala accés fàcil  
Easy access ladder  
18505: 5 peldaños  
18506: 6 peldaños  
18507: 7 peldaños  
18705: 5 peldaños  
18706: 6 peldaños  
18707: 7 peldaños

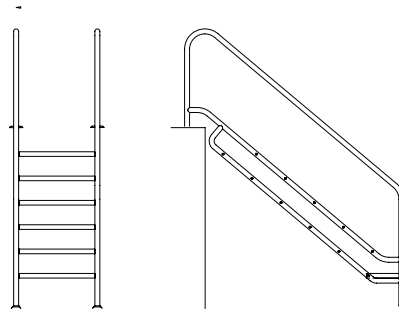

18403/18404

AL

Escalera Sky  
Escala Sky  
Sky ladder  
Peldaños  
Esglaons  
Steps:  
18403: 3  
18404: 4



OOLOGY 400 TRANSPORTABLE

Peso máximo 150 kgs.  
 2 baterías + cargador. Hidráulico. IP 65,  
 accionado desde botonera transportable  
 Plataforma base con contrapesos. 4 ruedas  
 (2 giratorias)  
 Pes màxim 150 kgs.  
 2 bateries + carregador. Hidràulic. IP 65,  
 accionat des de botonera transportable.  
 Plataforma base amb contrapesos. 4 rodes  
 (2 giratòries)  
 Maximum weight 150 kgs.  
 2 batteries + and fixed charger. Hydraulic.  
 IP 65, operated from transportable button.  
 Base platform with counterweights. 4 wheels  
 (2 swivels).

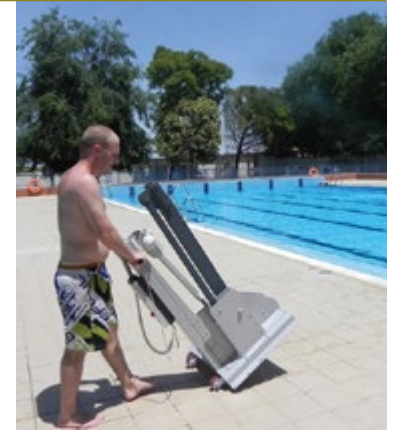

OOLOGY K2 HIDRÁULICO FIJO



Peso máximo 150 kgs.  
 Hidráulico, fijo y desmontable.  
 Usuario autónomo

Pes màxim 150 kgs.  
 Hidràulic, fix i desmuntable.  
 Usuari autònom.

Maximum weight 150 kgs.  
 Hydraulic, fixed and detachable.  
 Non-assisted user.

OOLOGY PK PORTÁTIL HIDRÁULICO

Peso máximo 150 kgs.  
 Hidráulico, portátil y transportable  
 Usuario autónomo.

Pes màxim 150 kgs.  
 Hidràulic, portàtil i transportable.  
 Usuari autònom.

Maximum weight 150 kgs.  
 Hydraulic, portable and transportable.  
 Non-assisted user.

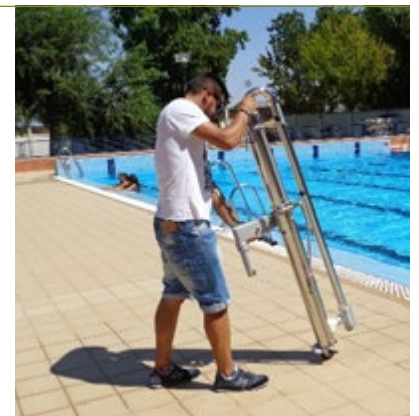

GRUA PISCINA Y ZÓCALO GPZ001

Arnés estandar con barra  
 Peso máximo 135 kg.  
 Arnès estandar amb barra  
 Pes màxim 135 kg.  
 Standard harness with bar  
 Maximum weight 135 kg.

Zócalo

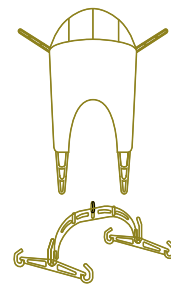
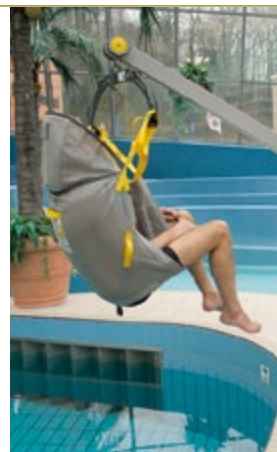

GPZ3431

ELEVADOR MOVIL BLUONE DG81

Peso máximo 120 kgs.  
 Hidráulico, portátil y transportable  
 Usuario autónomo.

Pes màxim 120 kgs.  
 Hidràulic, portàtil i transportable.  
 Usuari autònom.

Maximum weight 120 kgs.  
 Hydraulic, portable and transportable. Non-assisted user.

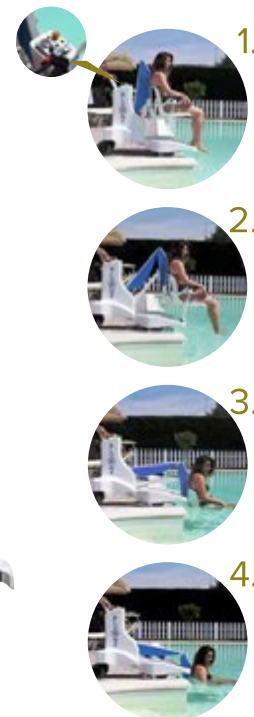

OLOGY 34 BATERÍA

Peso máximo 120 kgs.  
 Batería y reposapiés.  
 Usuario asistido.  
 Movimiento vertical.

Pes màxim 120 kgs.  
 Bateria i reposapeus.  
 Usuari assistit.  
 Moviment vertical.

Maximum weight 120 kgs.  
 Battery and footrest.  
 Assisted user.  
 Vertical movement.



20000

70x45 cm.  
Aro salvavidas lona  
Cèrcol salvavides lona  
Canvas life ring



20001

75x47 cm.  
Aro salvavidas plástico  
Cèrcol salvavides plàstic  
Plastic life ring



20100

INOX

Soporte aro salvavidas  
Suport aro salvavides  
Life ring support



20101

INOX

Soporte aro salvavidas varilla  
Support aro salvavides vareta  
Life ring support bracket



20102

INOX

Soporte aro salvavidas sencillo  
Suport aro salvavides senzill  
Simple life ring support



20103

INOX

Ø 43 x 150 cm.

Soporte aro salvavidas pie  
Suport aro salvavides peu  
Standing life ring support



20200

AL

Floty



20201

AL

Lifeguard



20300/20301

AL

INOX

20300: Ø 20 x 200 cm.  
Monitor triangular

20301: Ø 20 x 200 cm.  
Monitor curvat/curved



20400

INOX

AL

Silla socorrista  
Cadira socorrista  
Lifeguard chair  
Inox.



20401

INOX

AL

Silla socorrista  
Cadira socorrista  
Lifeguard chair  
Aluminio



20500

Maniquí socorrismo  
Maniquí socorrisme  
Livesaving dummy



20600



Silla anfibia minusválidos  
Cadeira amfibia minusvàlids  
Handicapped water chair



20700

Tablero espinal inc. correa araña  
Tauler espinal inc corretja aranya  
Spinal board inc. spider strap



20701: Recambio correa araña  
Recambi corretja aranya/Spider  
strap spare part

20702



Collar inmovilizador  
Collar immobilitzador  
Collar immobilizer



20703

Camilla portatil  
Portable stretcher



20704

Camilla de exploración  
Llitera d'exploració  
Exploration stretcher



20705

Resucitador de adultos  
Ressuscitador per a adults  
Adult resuscitator



20706

Camilla plegable/Llitera plegable  
Folding stretcher  
208x55x13 cms. abierta  
104x17x9 cm. cerrada



20707

Camilla apilable/Llitera apilable  
Stackable stretcher  
187x50x18 cm.



20800

Botiquín completo nylon  
Botiquí complet niló  
Complete first aid kit nylon



20801/20811

Botiquín plástico  
Farmaciola plastic  
Plastic first aid kit  
20801: vacío  
20811: completo



20803/20833

Armario botiquín metálico  
con llave  
Armari farmaciola metàl·lic  
amb clau  
First aid kit metal cupboard  
with key  
20803: vacío  
20833: complet



20900

Panel caballete  
Panell cavallet  
Sign board



RA40

INOX

Reloj piscina analógico  
 Rellotge piscina analògic  
 Analog pool clock  
 Ø 40 cm.



RA60

INOX

Reloj piscina analógico  
 Rellotge piscina analògic  
 Analog pool clock  
 Ø 60 cm.



RA80

INOX

Reloj piscina analógico  
 Rellotge piscina analògic  
 Analog pool clock  
 Ø 80 cm.



RC400

Cronómetro 4 agujas  
 Cronòmetre 4 agulles  
 4 Hand chronometer  
 80x80 cm.



RC460/RC480

INOX

Cronómetro 4 agujas caja inox.  
 Cronòmetre 4 agulles caixa inox.  
 4 Hand chronometer inox. box  
 RC460: Ø 60 cm.  
 RC480: Ø 80 cm.



RC500

INOX

Cronómetro portátil  
 Cronòmetre portàtil  
 Portable chronometer  
 Ø 50 cm.



RCV10

Cuenta vueltas  
 Compte voltes  
 Lap timer



RMC/RAC

RMC:  
 Recambio motor cronómetro  
 Recanvi motor cronòmetre  
 Motor chronometer spare part

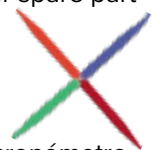

RAC:  
 Recambio agujas cronómetro  
 Recanvi agulles cronòmetre  
 Clock hands spare parts

RD2000

Reloj digital doble temperatura  
 Rellotge digital doble temp.  
 Double temperature digital  
 clock



RD3000

Reloj temperatura higrómetro  
 Rellotge temp. higrómetro  
 Higrómetro  
 temperature  
 clock



RD3001

Temperatura higrómetro  
 Higrómetro temperature



## RD410

35x18,5 cm. Digit. 10 cm.  
Reloj digital 4 dígitos  
Relotge digital 4 dígits  
4 Digit digital clock



## RD610

51x18 cm. Digit. 10 cm.  
Reloj digital 6 dígitos  
Relotge digital 6 dígits  
6 Digit digital clock



## RD420

63x30 cm. Digit. 20 cm.  
Reloj digital 4 dígitos  
Relotge digital dígits  
4 Digit digital clock



## RD620

92x30 cm. Digit. 20 cm.  
Reloj digital 6 dígitos  
Relotge digital 6 dígits  
6 Digit digital clock



### Parámetros del relé ejecutivo incorporado

Tipo de contacto	NO (Normal abierto)
Max. corriente	5A
Max. voltaje	250 V
Max. potencia	100 W

## Opcionales

Ref.	Descripción	
RD-STA	Sensor de temperatura ambiente	La temperatura es mostrada alternadamente junto con la hora y la fecha, pudiendo ajustarse el tiempo de visualización de cada uno de ellos. Rango de temperatura: -50°C ÷ +99°C
RD-STP	Sensor de temperatura de agua/piscina (h)	La temperatura es mostrada alternadamente junto con la hora y la fecha, pudiendo ajustarse el tiempo de visualización de cada uno de ellos. Este sensor es hermetico para su introducción en el agua. Rango de temperatura: -50°C ÷ +99°C
RD-EXC	Extensión de cables	Longitud del cable de alimentación: 2m. Posibilidad de extensión hasta 100m Longitud del cable del sensor de temperatura: 10m. Posibilidad de extensión hasta 50m. Longitud del cable de la antena GPS : 10m Posibilidad de extensión hasta 50m

REJILLA SUELO VINILO

10 mt.



Descripción	← →	↑ ↓	Ref.
Alfombra rejilla suelo vinilo. Catifa reixeta terra vinil. Plastic grating mat.	60 cm.	10 mt.	22660
	80 cm.	10 mt.	22680
	100 cm.	10 mt.	22610

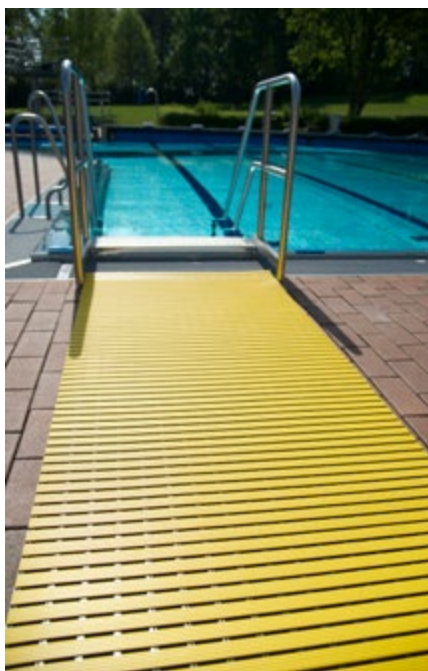

REJILLA LAMAS PLÁSTICO

10 mt.



Descripción	← →	↑ ↓	Ref.
Alfombra lamas plástico. Catifa làmines plàstic. Carpet plastic slats.	60 cm.	10 mt.	22760
	80 cm.	10 mt.	22780
	100 cm.	10 mt.	22710

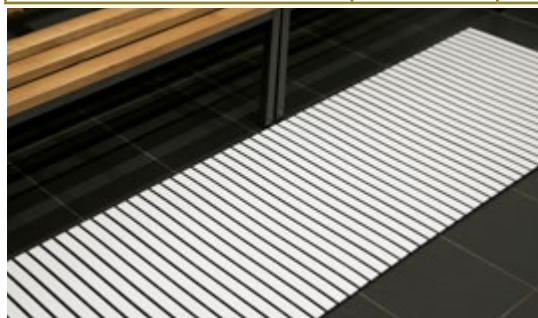

22500



40x40 cm.  
Loseta suelo.  
Lloseta sòl.  
Floor tiles.

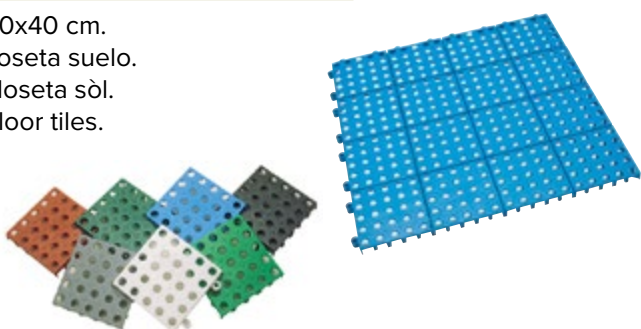



22800

**PASARELA DE PLAYA** es una pieza de plástico reciclable prevista para ser depositada sobre superficies irregulares que requieran del paso de personas.

**PASSARELA DE PLATJA** és una peça de plàstic reciclable prevista per ser dipositada sobre superfícies irregulars que requireixin del pas de persones.

**BEACH PASARELA** is a piece of recyclable plastic designed to be deposited on irregular surfaces that require the passage of people.

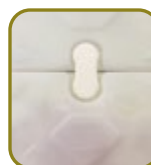
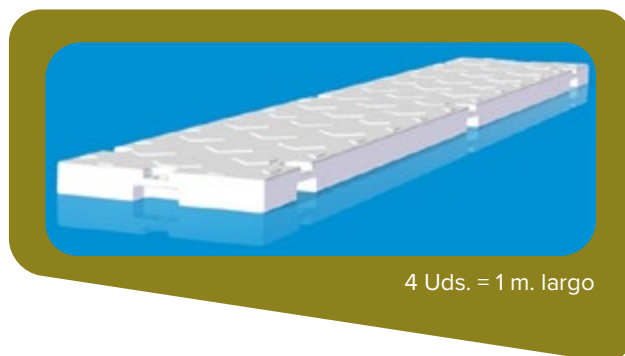

Unión con plástico  
Unió amb plàstic  
Plastic union



Unión con cuerda  
Unió amb corda  
Rope union

- ✓ Está fabricada en un material termoplástico (PE-HD).
- ✓ Resistente a los rayos ultravioleta (UV).
- ✓ El peso por elemento es de 2 kg.
- ✓ Dimensiones 1500 x 250 x 40 mm.
- ✓ Alta resistencia al impacto y peso (+7.000 Kg. ).
- ✓ Fácil instalación (tanto al montar como al desmontar).
- ✓ Cómodo acceso a personas con movilidad reducida.
- ✓ Ancho homologado para cruce de 2 sillas de ruedas.
- ✓ Versión PRO con iluminación.
- ✓ Durabilidad garantizada a 5 años (ver condiciones de uso).
- ✓ Antideslizante.

- ✓ Està fabricada en un material termoplàstic (PE-HD).
- ✓ Resistent als raigs ultraviolats (UV).
- ✓ El pes per element és de 2 kg.
- ✓ Dimensions 1500 x 250 x 40 mm.
- ✓ Alta resistència a l'impacte i el pes (+7.000 Kg. ).
- ✓ Fàcil instal·lació (tant al muntatge com al desmuntar).
- ✓ Còmode accés persones amb mobilitat reduïda.
- ✓ Ample homologat per a creuament de 2 cadires de rodes.
- ✓ Versió PRO amb il·luminació.
- ✓ Durabilitat garantida a 5 anys (veure condicions d'us).
- ✓ Antilliscant.

- ✓ It is made of a thermoplastic material (PE-HD).
- ✓ Resistant to ultraviolet rays (UV).
- ✓ The weight per element is 2 kg.
- ✓ Dimensions 1500 x 250 x 40 mm.
- ✓ High impact resistente and weight (+7.000 Kg. ).
- ✓ Easy installatinn (both mounting and dismantling).
- ✓ Comfortable access to people with reduced mobility.
- ✓ Approved width for the crossing of 2 wheelchairs.
- ✓ PRO version with lights.
- ✓ Guaranteed durability for 5 years (see conditions of use).
- ✓ Non-slip.



POLIPERCHA



Polipercha/Poliperxa/Hangers

- 22300: corta sin bolsa/curta sense bossa/short without bag
- 22301: corta con bolsa/curta amb bossa/short with bag
- 22302: larga sin bolsa/llarga sense bossa/long without bag
- 22303: larga con bolsa/llarga amb bossa/long with bag
- 22304: bolsa/bossa/bag



V400



Cambiador bebé horizontal  
Canviador bebè horitzontal  
Horizontal baby changer



V500



Cambiador bebé vertical  
Canviador bebè vertical  
Vertical baby changer



V600



Trona bebé  
Baby high chair



PULSERA TAQUILLA



- 22400:  
Pulseras llave taquilla sin numerar  
Pulseres clau guixeta sense numeració  
Lockers key rings not numbered
- 22401: 15 mm.  
Pulsers taquilla/pulseres guixeta/  
locker key ring
- 22402:  
Pulseras taquilla completa numerada  
Pulseres guixeta completa numerada  
Complete numbered key ring



22406 TAQUILLAS

Taquillas a medida en PVC o fenólico  
Guixeta a mida en PVC o fenòlic.  
Made to measure locker in PVC or phenolic.



SOPORTE LLAVE



- Soporte llaves/suport clau/key supports
- 22403: numerados/numerat/ numbered
- 22404: sin numerar/sense numerar/not numbered
- 22405: contraseñas plástico/  
contrasenyes plàstic/plastic access code



SECA BAÑADORES



EXTRAE HASTA EL 95%  
DEL AGUA EN 10 SEGUNDOS



22500



22501



22502



22503



22504



22505



22506

Más **confort** para sus clientes

Más **higiene** en el vestuario

Menos **agua** en el vestuario

Menos **humedad** en la bolsa

Menos malos **olores**

Menos **moho** y **bacterias**

**Seguro** e higiénico

Fabricado para **durar**

Fácil de **instalar**

Uso **sencillo**

Fácil **mantenimiento**

**ESTRUCTURA Y COMPONENTES INOXIDABLES**

## ESTANTERÍA



Estanterías 4 estantes  
 Prestatgeries 4 prestatges  
 4 Hanger shelf  
 22010: 100x50x150 cm.  
 22012: 120x50x150 cm.  
 22015: 150x50x150 cm.  
 22020: 200x50x150 cm.



## ARMARIO ALMACENAJE



Armario 90cm con 4 estantes  
 22090: 90x45x184 cm.  
 22091: 90x45x100 cm.



## PORTA TAPICES



Estanterías porta tapices  
 Prestatgeries porta tapís  
 Playraft shelves  
 22013-T: 130x70x137 cm.  
 22020-T: 200x70x240 cm.

## BANCO VESTUARIO



Bancos de vestuario  
 Bancs de vestuari  
 Changing room bench  
 22100: 100x40x48.5 cm.  
 22150: 150x40x48.5 cm.  
 22200: 200x40x48.5 cm.



## BANCO CON BASTIDOR



Banco con bastidor  
 Banc amb bastidor  
 Bench with frame  
 22210: 150x56x175 cm.  
 22220: 150x92x175 cm.



22510/22515/22520



Banco almacenamiento/Banc emmagatzematge/Bench with storage box



22510: 100x49x49 cm.  
22515: 150x49x49 cm.  
22520: 200x49x49 cm.

22538/22538P/22523



Almacenaje/Magatzematge/Storage



22538: 138x60x177 cm.



22538P: 138x60x177 cm.

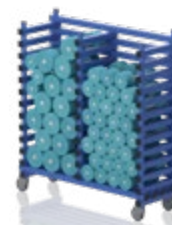

22523: 123x42x133 cm.

22544/22598/22555/22594



Almacenaje/Magatzematge/Storage



22544: 144x69x111 cm .



22598: 198x69x111 cm.



22555: 105x102x170 cm.



22594: 194x102x170 cm.

22900



Plataforma elevada/Depth reducing underwater pool platforms

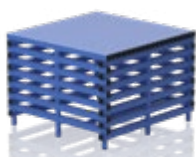

22800: 100x100x70 cm. \* Barandilla adicional



COLORES  
DISPONIBLES

Azul	
Beige	
Rojo	
Amarillo	
Gris	
Turquesa	

21200



Cesta contenedor  
Cistella contenidor  
Container basquet



21300



100x830x800 cm.  
Carro acero inox.  
Carretó acer inox.  
Stainless steel cart.



CARRO PVC CON PUERTA



Carro PVC  
Carretó PVC  
PVC Transportation trolley

147x70x98 cm.  
21400: con puerta y ruedas  
plástico/amb porta i rodes plàstic/  
with door & plastic wheels

21401: con puerta y ruedas metal/  
amb porta i rodes metall/with door  
& metal wheels

120x 100x99 cm.  
21405: con puerta y ruedas metal/  
amb porta i rodes metall/with door  
& metal wheels

21407: con puerta y ruedas  
plástico/amb porta i rodes plàstic/  
with door & plastic wheels



CARRO PVC SIN PUERTA



Carro PVC sencillo  
Carretó PVC senzill  
Simple PVC trolley

110x100x99 cm.  
21404: sin puerta y ruedas metal/  
sense porta i rodes metall/without  
door & metal wheels

21406: sin puerta y ruedas plástico/  
sense porta i rodes plàstic/without  
door & plastic wheels

120x70x93 cm.  
21402: sin puerta y ruedas plástico/  
sense porta i rodes plàstic/without  
door & plastic wheels

21403: sin puerta y ruedas metal/  
sense porta i rodes metall/without  
door & metal wheels

21500



69x53x96 cm.  
Contenedor para fritas  
Contenidor per fritas  
Noodles container

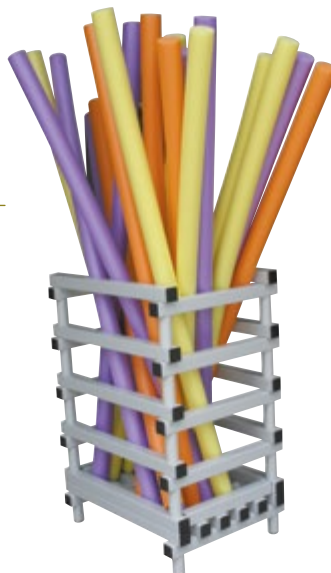

21600



75x45x200 cm.  
10 Steps  
Carro transporte  
Carretó transport  
Transport Trolley



## 21700 MEDITERRÁNEO



Tumbona plegable con ruedas, respaldo abatible 4 posiciones. Resistente a la humedad y rayos UV.

Tumbona plegable amb rodes, suport abatible 4 posicions. Resistent a la humitat i raigs UV.

Folding deck chair with wheels, folding backrest 4 positions. Resistant to moisture and UV rays.



## 21710 MOON



Tumbona apilable, respaldo abatible en 3 posiciones.

Tumbona apilable, suport abatible en 3 posicions.

Stackable Deck chair, folding backrest 3 positions.



## 21720 FLAMINGO



Tumbona plegable con ruedas y reposabrazos.

Tumbona plegable amb rodes i reposabraços.

Folding deck chair with wheels and armrest.



## 21730 SOUL



Tumbona plegable con ruedas.

Tumbona plegable amb rodes.

Folding deck chair with wheels.



Césped artificial jardines mantenimiento  
Gespa artificial jardins manteniment  
Artificial grass for garden maintenance



Césped artificial instalaciones deportivas  
Gespa artificial instal·lacions esportives  
Artificial grass sports facilities



Césped artificial jardín/piscina  
Gespa artificial jardí/piscina  
Artificial grass for gardens/swimming pools



Suministramos e instalamos todo tipo de cubiertas hechas a medida: fijas, móviles, adosadas, telescópicas, abovedadas y elevadas.

Subministrem i instal-lem tot tipus de cobertes fetes a mida: fixes, mòbils, adossades, telescòpiques, voltades i elevades.

We supply and install all kinds of custom-made pool roofs: fixed, mobile, semi-detached, telescopic, vaulted and raised.



ADOSADA



ROLL





## ENROLLADORES AUTOMATICOS Y MANUALES



Suministramos e instalamos todo tipo de enrolladores hechos a medida: automáticos y manuales.



Subministrem i instal·lem tot tipus de enrolladores fets a mida: automàtics i manuals.

We supply and install all kinds of custom-made winders: automatic and manual.

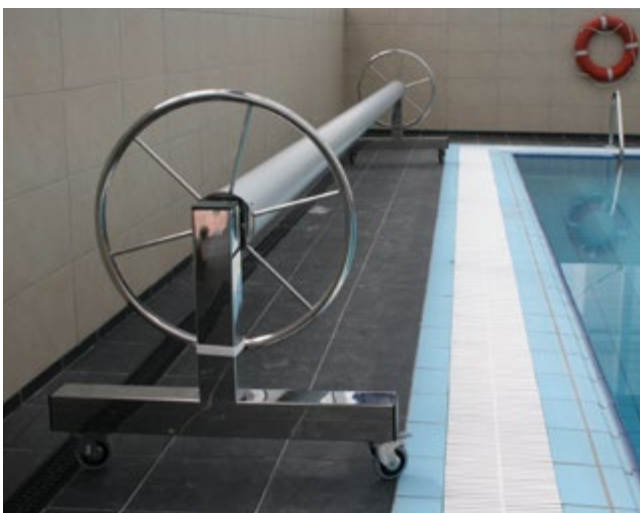

## BOMBA DE CALOR GRAN CAPACIDAD

- Disponible en versiones 43 kW y 95 kW
- Gas R410A
- Compresor COPELAND SCROLL
- Reversible (unidad de calefacción y refrigeración)
- Carrocería de chapa, pintura anticorrosión
- Conexión hidráulica 63 mm o 110 mm
- Sistema desescarche por inversión de ciclo
- Conexión maestro-esclavo hasta 32 unidades
- Funcionamiento hasta - 15°C



## ENERGYLINE



- Adecuada para las piscinas de gran volumen, hasta 200 m<sup>3</sup>
- Diseñada específicamente para una utilización en todas las estaciones, en condiciones extremas a temperaturas hasta - 12°C
- Ideal para piscinas interiores y/o regiones frías
- El ventilador inverter adapta su velocidad de rotación en función de la temperatura del aire y funciona al ralentí en el modo nocturno, muy silencioso
- Desescarche automático por inversión de ciclo
- Compresor scroll Emerson Copeland
- Arranque electrónico progresivo
- Función reversible y automática para calentar y enfriar la piscina con prioridad para calentar

## BOMBAS

Bombas para piscinas Pública y Privada desde 1/2HP a 15 HP



## FILTROS

Filtros para piscinas Pública y Privada soplados, inyectados y laminados



## SISTEMAS DE TRATAMIENTO UV

- Gama completa de desinfección mediante UV-MP
- UV para piscinas públicas y spas
- Agua en perfecto equilibrio mediante tratamiento UV-MP
- Tratamiento físico "eco-friendly" respetuoso con la salud y el medio ambiente
- Tubo de cuarzo de gran pureza
- Sistema de limpieza manual o Automática
- Pantalla táctil\* elegante e intuitiva
- Control de temperatura del reactor y de la caja de control
- Programación on/off personalizable (ahorro energético)



50000

Cascada residencial  
Residential waterfall



50001

Cañón residencial boca circular  
Canó d'aigua boca circular  
Round jet residential canon



50002

Cañón residencial boca plana  
Canó d'aigua boca plana  
Flat jet residential canon



50200

Recoge hojas de superficie  
Recullidor fulles de superfície  
Superficial leaf collector



50201

Recoge hojas de fondo  
Recullidor fulles de fons  
Bottom leaf collector



50202

Cepillo de fondo curvo  
Raspall de fons corb  
Curved bottom brush



50300/50400

50300: 2,50-5 mts.  
Mango telescópico  
Mànc telescòpic  
Telescopic handle



50400

Termómetro flotante  
Termòmetre flotant  
Floating thermometer



ROBOTS RESIDENCIAL

Diferentes modelos para piscina  
Diferents models per a piscina  
Different types for private pools



TRX7500IQ

Robot VORTRAX  
Para cable 25 m.



50250

Robot ARCO. Cable 30 m.  
Piscina pública hasta 25 m.



50500

Robot ARCOMAX. Cable 40 m.  
Piscina pública hasta 50 m.



DELAYED  
START



SMART  
NAVIGATION



INFRARED  
SENSOR



TURBO  
MODE

Específicamente diseñado para un uso intensivo en piscinas públicas

Sensores infrarrojos. para detectar las paredes y obstáculos.

Giroscopio y sistema de navegación inteligente con brújula.

Sistema de tracción con orugas para uso intensivo.

Aspiración ultra potente.

Control remoto para uso manual.

Ddeagua Construcción, Rehabilitación y Reparación  
Piscinas Públicas y Residenciales

# Impermeabilización

Para todo tipo de superficies

d ■ d e  
a g u a

*Instalador  
recomendado por  
OLOGY*



NOTAS 1.

---

---

---

NOTAS 2.

---

---

---

NOTAS 3.

---

---

---

NOTAS 4.

---

---

---

NOTAS 5.

---

---

---



*PARA DESCUBRIR  
MÁS ARTÍCULOS DE  
PSICOMOTRICIDAD,  
DESCÁRGATE NUESTRO  
CATÁLOGO*



# CALENDARIO 2023

## Enero 2023

Lu	Ma	Mi	Ju	Vi	Sa	Do
						1
2	3	4	5	6	7	8
9	10	11	12	13	14	15
16	17	18	19	20	21	22
23	24	25	26	27	28	29
30	31					

## Febrero 2023

Lu	Ma	Mi	Ju	Vi	Sa	Do
		1	2	3	4	5
6	7	8	9	10	11	12
13	14	15	16	17	18	19
20	21	22	23	24	25	26
27	28					

## Marzo 2023

Lu	Ma	Mi	Ju	Vi	Sa	Do
		1	2	3	4	5
6	7	8	9	10	11	12
13	14	15	16	17	18	19
20	21	22	23	24	25	26
27	28	29	30	31		

## Abril 2023

Lu	Ma	Mi	Ju	Vi	Sa	Do
					1	2
3	4	5	6	7	8	9
10	11	12	13	14	15	16
17	18	19	20	21	22	23
24	25	26	27	28	29	30

## Mayo 2023

Lu	Ma	Mi	Ju	Vi	Sa	Do
1	2	3	4	5	6	7
8	9	10	11	12	13	14
15	16	17	18	19	20	21
22	23	24	25	26	27	28
29	30	31				

## Junio 2023

Lu	Ma	Mi	Ju	Vi	Sa	Do
			1	2	3	4
5	6	7	8	9	10	11
12	13	14	15	16	17	18
19	20	21	22	23	24	25
26	27	28	29	30		

## Julio 2023

Lu	Ma	Mi	Ju	Vi	Sa	Do
					1	2
3	4	5	6	7	8	9
10	11	12	13	14	15	16
17	18	19	20	21	22	23
24	25	26	27	28	29	30
31						

## Agosto 2023

Lu	Ma	Mi	Ju	Vi	Sa	Do
	1	2	3	4	5	6
7	8	9	10	11	12	13
14	15	16	17	18	19	20
21	22	23	24	25	26	27
28	29	30	31			

## Septiembre 2023

Lu	Ma	Mi	Ju	Vi	Sa	Do
				1	2	3
4	5	6	7	8	9	10
11	12	13	14	15	16	17
18	19	20	21	22	23	24
25	26	27	28	29	30	

## Octubre 2023

Lu	Ma	Mi	Ju	Vi	Sa	Do
						1
2	3	4	5	6	7	8
9	10	11	12	13	14	15
16	17	18	19	20	21	22
23	24	25	26	27	28	29
30	31					

## Noviembre 2023

Lu	Ma	Mi	Ju	Vi	Sa	Do
		1	2	3	4	5
6	7	8	9	10	11	12
13	14	15	16	17	18	19
20	21	22	23	24	25	26
27	28	29	30			

## Diciembre 2023

Lu	Ma	Mi	Ju	Vi	Sa	Do
				1	2	3
4	5	6	7	8	9	10
11	12	13	14	15	16	17
18	19	20	21	22	23	24
25	26	27	28	29	30	31



Energía, 16 · Pol. Ind. Famades  
08940 Cornellá de Llobregat (Barcelona)  
T. 93 377 72 52  
E. comercial@ology.es  
www.ology.es

